

# Try The Trenton Terror

by Mickey DeAngelis

drawings by Bill Giblin

**“HOW MUCH WILL IT COST? AND HOW WILL THE FINISHED JOB PERFORM?” QUESTIONS SUCH AS THESE ALWAYS COME TO MIND WHEN A CHAP’S PLANNING TO BUILD A GAS MODEL. AND IN THE CASE OF THE “TRENTON TERROR” HE’LL RECEIVE MIGHTY SATISFYING ANSWERS. FOR THE ENTIRE CONSTRUCTIONAL COST OF THE CRAFT, MINUS THE ENGINE, SHOULDN’T RUN MORE THAN FOUR DOLLARS.**

**AND AS FOR PERFORMANCE, WELL—JUST FOLLOW THE ACCOMPANYING INSTRUCTIONS TO THE LETTER, AND YOU’LL HAVE A RECORD BREAKER!**

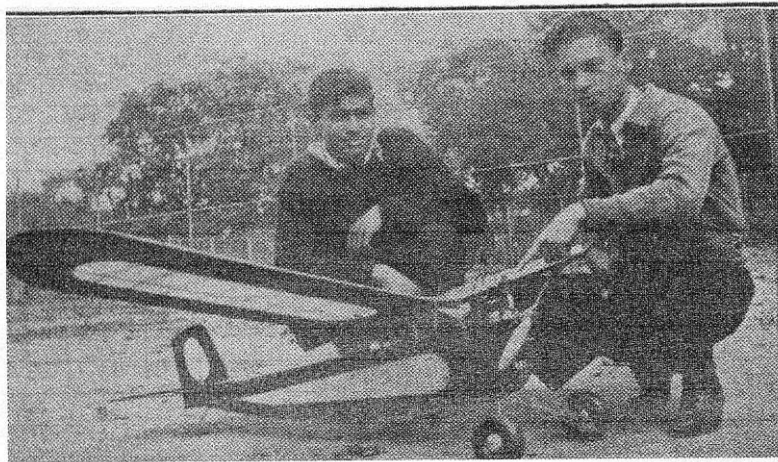

*Introducing Miss Trenton 111—better known as the “Trenton Terror”—with Barney Onofri, its builder, and Mickey DeAngelis, its designer. Sturdy and stable and with easily adjustable controls, this ship was making quite a reputation in the East before the travel bug bit her and she failed to return from an exhibition flight.*

**S**IMPLE DESIGN coupled with topnotch performance and low cost of construction are the keynotes of our *Trenton Terror*. And the fact that at least ten *Terrors* have been built in Trenton during the past few months (up to the time of writing) is proof enough that the ship is both practical and popular.

That “low cost” feature is one reason for its popularity, of course. For the *Terror* can be built and even equipped with airwheels for an expenditure of but little more than \$4.00.

Obviously, this doesn’t include the engine—but you might figure on a medicine dropperful of gas within that price!

The ship has performed very well indeed at a round half-dozen large contests in the East. And in the recent Metropolitan Gas Model Meet at Seversky Field, Long Island, the stable performance of the plane astonished spectators and contestants alike. For other models were cracking up right and left in the very high wind that marked the day—while the *Trenton Terror* flew calmly on!

And at a State Recreation Festival at Roosevelt Park, N.J., a short time ago, the *Trenton Terror* was staging an exhibition flight from a small island in a lake to the “mainland.” From a swell take-off, all went well! But the motor conked out while the ship was right above the water—and she made what the old fiction writers used to call a “volplaning dive” to a perfect three-pointer on the drink!

The airwheels served efficiently as pontoons, and when we—Barney Onofri, who had built the original model from my plans, and myself—had retrieved it, we shook the water off and sent the ship up again. But by that time the *Terror* herself was terrorized—for she flew out of sight and hasn’t been seen since.

Which brings us to the moral of our story, Never fly your *Trenton Terror*—or any other favorite model—without first firmly affixing your name and address in a conspicuous place.

## CONSTRUCTION

THE first step in constructing any type of model is to become familiar with the construction data and drawings.

Scale up the fuselage sides from Plates 1 and 4, and then lay out the two sides. Build over the white outlines only—the solid black lines show the V-type turtle deck which is added after the fuselage sides have been assembled. The entire fuselage is constructed of 1/4" sq. hard balsa, and plenty of cement is used on every joint. A straight pin should also be inserted through every joint to further reinforce the structure.

The battery track (Plate 1) is merely a balsa runway to which the battery box (Plate 2) is bolted. By moving the batteries backward or forward the ship can be adjusted for nose or tail heaviness as may be required. The V-type turtle deck is made by first running a square balsa strip edgewise from the center of the top rear cross-piece of the cabin to the center of the last cross-piece on the rear of the fuselage. The additional cross-pieces are then run as shown from the edges of the fuselage to this strip to form the triangular shaped turtle deck, as shown in black on Plate 1.

The door is made of 1/8" balsa sheet with a linen or cotton hinge, and a piece of wire for a lock. This door makes it very easy to change batteries, adjust balance, or check wiring.

The landing gear (Plate 4) is bent from 1/8" dia. spring steel wire. Use soft brass wire to hold it together while soldering. You must have plenty of heat on your work to make a good soldering job.

The landing gear is held onto the fuselage cross-pieces with 1/8" flat rubber.

## MOTOR MOUNT

MAKE the "Y" motor mount panel and cement it to the cross-pieces as shown in Plate 1. This takes advantage of the 1/8" down-thrust already built into the fuselage. The "Y" panel is cut from 1/4" sheet plywood 3" wide by 4 1/2" long. It forms a flooring to which the motor is anchored. This is *Trenton's* "one-bolt

removable motor mount," a type that is instantly removable for adjustment.

The plywood panel, which is glued to the bottom of the motor mount skids, will give easily in a very hard crackup. This method has been in use for a year by Trenton builders and not one motor or crankshaft has been damaged in that time.

*Brown Jr.* motors use the original skids. For *Mighty Midgets, Syncro Ace, Ohlsson, Baby Cyclone* and similar motors, the mount must measure 2 1/4" wide, 4 1/2" long and 1 1/4" high. Use 3/8" hardwood sheet, with plywood as the base, to construct a mount as shown in Plate 4. Drill a 1/8" hole through the plywood, 1 1/8" from the front, to take the bolt. This bolt also passes through an extra piece of plywood 1/4" by 1" by 2" which acts as a washer and is used to protect the panel. A lock washer is put on the bolt and the nut is tightened, and the motor is then secure.

Any 1/5 or 1/6 h.p. motor may be used in this plane. The 1/5 h.p. motors must be offset 1/16" to the right. The motor is held tightly in place by hard balsa offset wedges 1 1/2" high by 4 1/2" long, and which taper from 1/2" to 1/16", as shown in Plate 1. These wedges give the necessary 1/16" side thrust.

## WING AND TAIL

A TEMPLATE of the wing rib (Plate 2) is the first step in making the wing. The ribs are cut from 1/16" hard balsa sheet. Twenty-four ribs are required for the entire wing. Be sure you make a right and left wing panel. Hard balsa strips 1/4" sq. are used for the wing spars. The leading edge is shaped from 1/2" by 3/4" balsa stripping. The wing tips are made from 1/4" sheet and are sanded to streamlined shape.

The dihedral angle, 6" on each tip, is put in when joining the left and right wing panels to the center section. The hard wood dihedral blocks are cemented to the side of the main spars as shown in Plate 3. Further strengthen the joints with thread wrapped around the spars and dihedral blocks. The dihedral blocks must be cut to fit your particular wing. Use plenty of 3/16" flat rubber to strap the wing to the fuselage.

Built of 1/4" sq. hard balsa, the stabilizer is very simple and needs but little explanation. The leading and trailing edges as well as the tips are sanded to a streamlined shape. Plate 3 shows in full size the wire fittings which pass through corresponding holes in the stabilizer. The fittings are bent to hook shapes after being inserted through the protecting aluminium plates. The fittings make the stab removable. Rubber loops are passed under the fuselage and onto the hooks to hold the stabilizer rigidly in place.

The rudder which is adjustable, is made of 1/4" square hard balsa. The leading and trailing edges are streamlined. The swivel post keeps the rudder rigid and at a 90 degree angle to the stabilizer. It is also the pivot on which the rudder turns, as is clearly shown on Plate 4. The wire guide, on which the aluminum fitting slides to give proper turn, is sunk into the leading edge of the stab and cemented. The aluminum fitting on the leading edge of the rudder is a device by which the rudder is held rigid after correct settings have been found.

### **FINAL INSTRUCTIONS**

COVER the entire model with bamboo paper and apply three coats of clear dope. The trim or panel effect is made with red tissue as shown in the picture.

Balance the model until it is slightly nose heavy, when it will be ready for test glides. If your *Trenton Terror* glides nicely and without left or right turn, put one scant eye-dropperful of fuel in the tank. Rev your motor at about one-fourth throttle and let 'er rip.

If the model climbs smoothly with a slight turn, it's okay to "turn her loose." Use judgment, of course, and don't let her get away from you. Limited fuel or an automatic timer on the ship will help in this respect. The adjustable rudder can be used to correct too much tendency to turn, and shifting the battery box along the balsa track will give you more weight toward the nose or tail.

### **BILL OF MATERIALS**

QUITE reasonable is the list of required material for the *Trenton Terror*. Beside the odds-and-ends that most modellers always have on hand, you only need the following:

Eighteen pieces hard balsa strips  $\frac{1}{4}$ " sq. by 60", one piece sheet balsa  $\frac{1}{4}$ "

by 3" by 36", one piece sheet balsa by 3" by 36", three pieces sheet balsa  $\frac{1}{16}$ " by 3" by 36", and two pieces balsa strips  $\frac{1}{2}$ " by  $\frac{3}{4}$ " by 36".

That's all for the balsa. In addition, you need one pint of clear dope,  $\frac{1}{2}$  pint glue, one five-foot length of  $\frac{1}{8}$ " dia. steel music wire, five sheets red Jap tissue, four sheets bamboo paper, and a small sheet of hard aluminum for fitting.

And so endeth the list. If you have any trouble either in building or flying the *Trenton Terror*, don't hesitate to write for help. Address me in care of FLYING Aces Magazine, 67 West 44th St., New York, N.Y. Tailwinds!

A FLYING ACES Magazine Plan

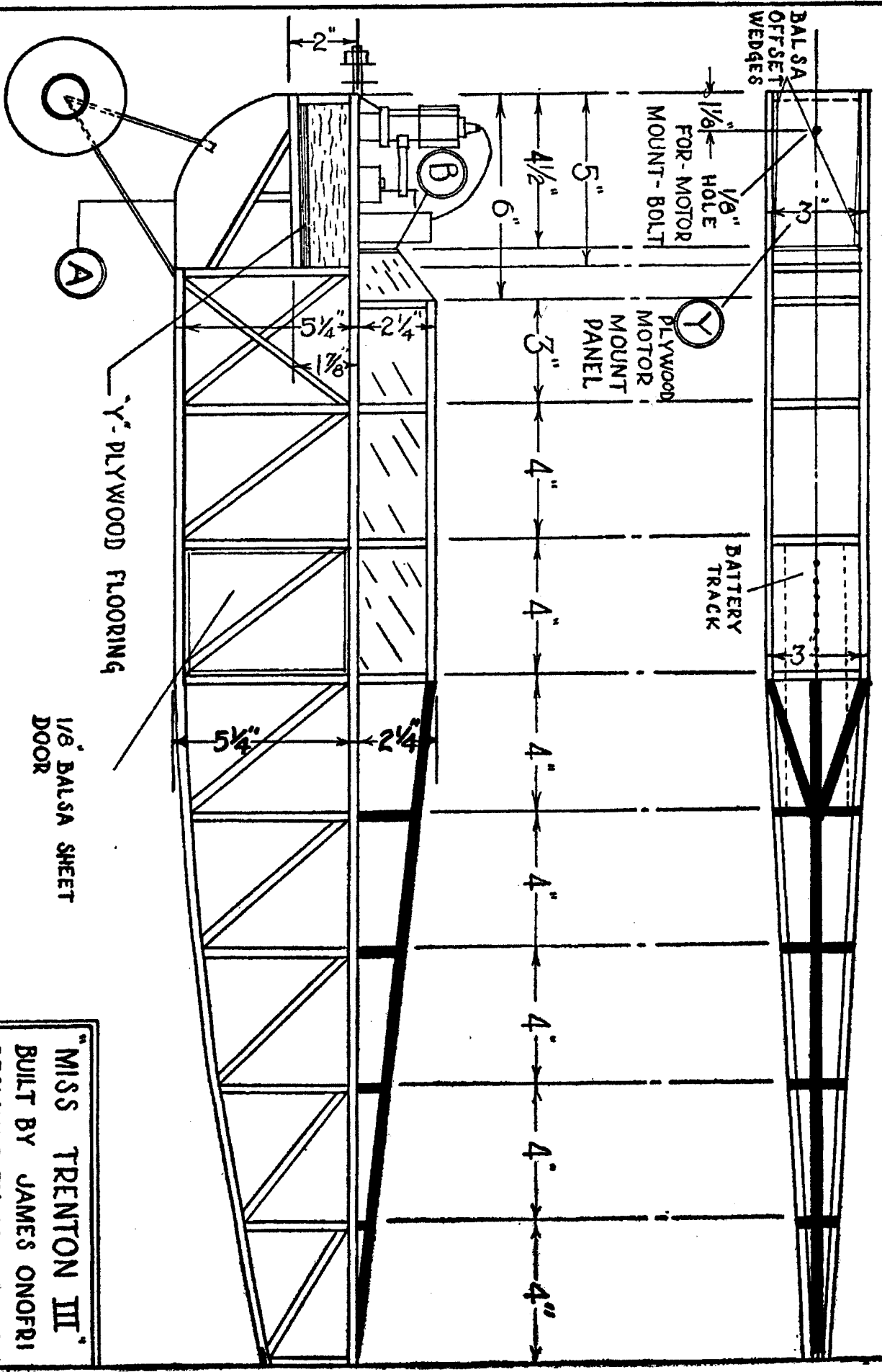

"MISS TRENTON III"  
BUILT BY JAMES ONOFRI  
DESIGNED BY—M. DE ANGELIS  
SCALE 1/4"=1"

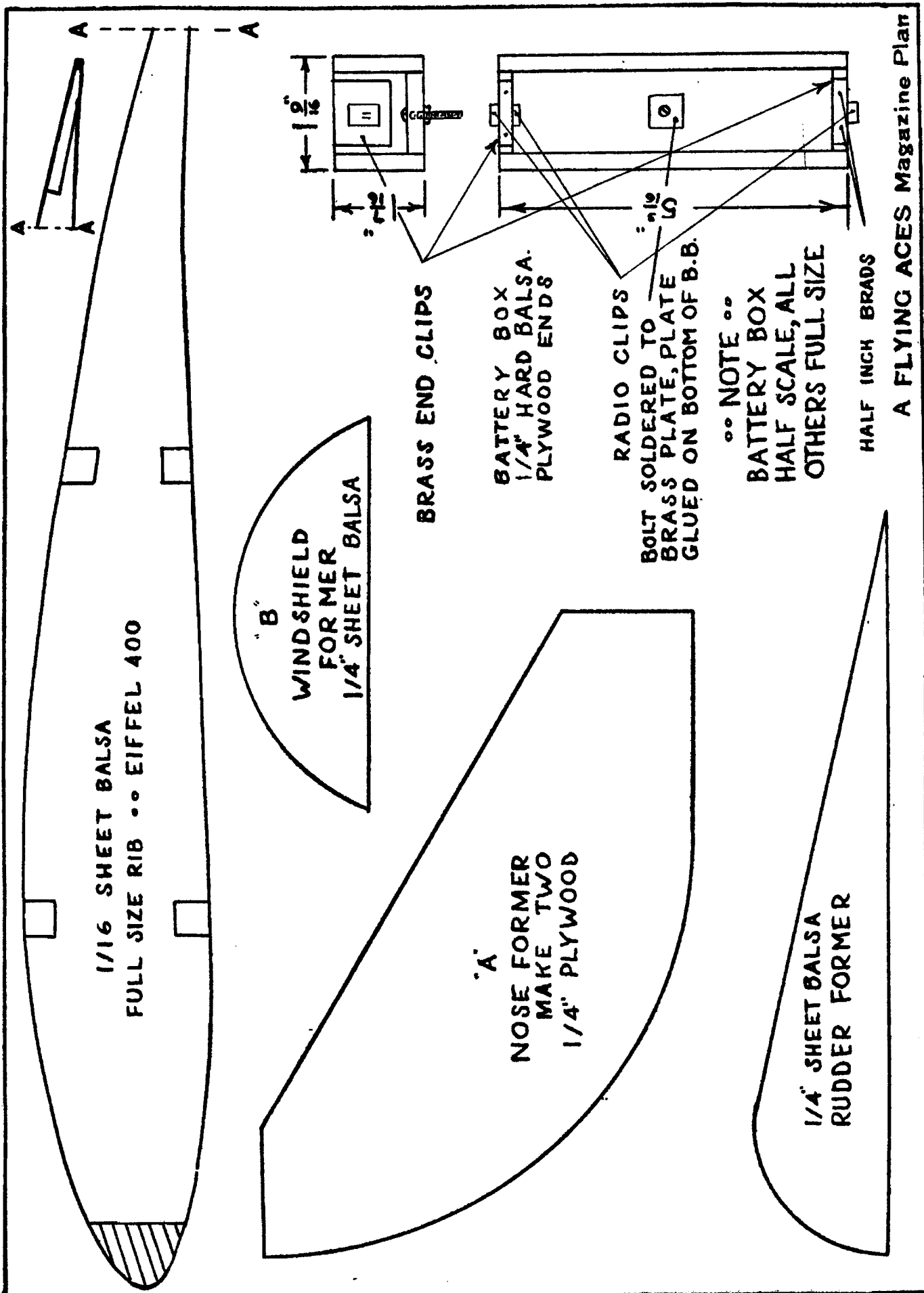

1/16 SHEET Balsa  
FULL SIZE RIB •• EIFFEL 400

"B"  
WINDSHIELD  
FORMER  
1/4" SHEET Balsa

"A"  
NOSE FORMER  
MAKE TWO  
1/4" PLYWOOD

1/4" SHEET Balsa  
RUDDER FORMER

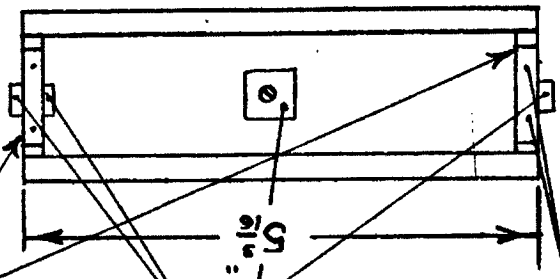
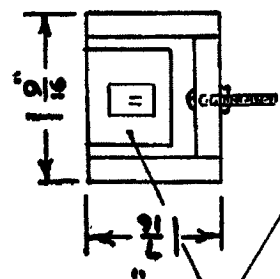

BRASS END CLIPS

BATTERY BOX  
1/4" HARD Balsa.  
PLYWOOD ENDS

RADIO CLIPS  
BOLT SOLDERED TO  
BRASS PLATE, PLATE  
GLUED ON BOTTOM OF B.B.

•• NOTE ••  
BATTERY BOX  
HALF SCALE, ALL  
OTHERS FULL SIZE

HALF INCH BRADS



NOTE.. 1/16 DIA. HOLES FOR WIRE FITTINGS.

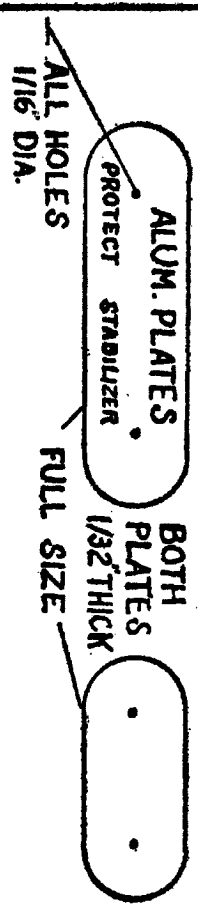
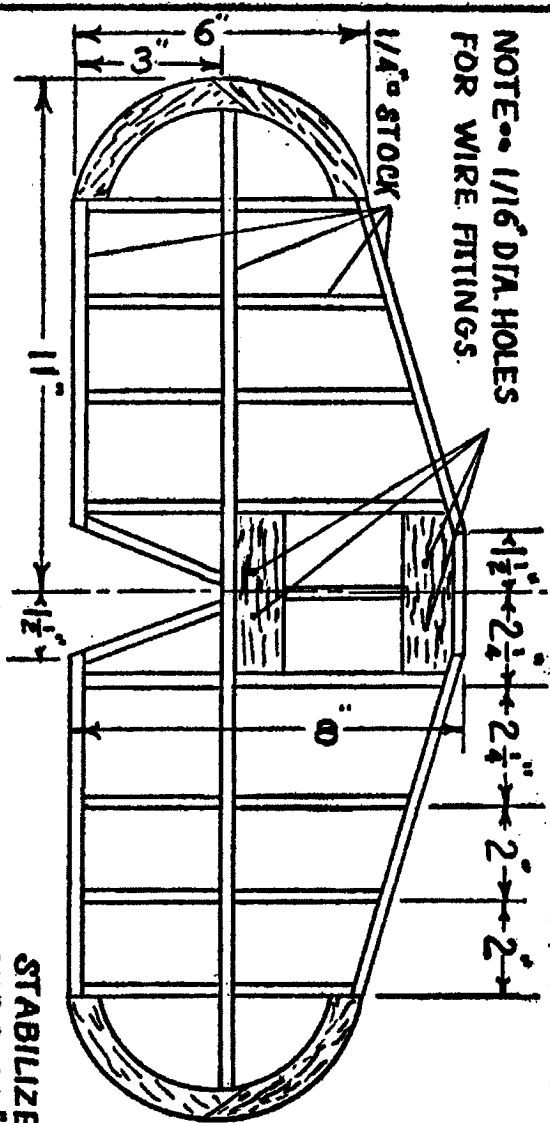

A FLYING ACES MAGAZINE PLAN

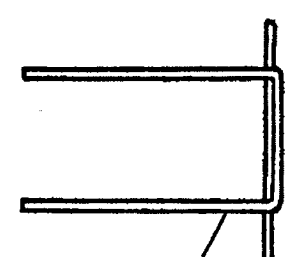

FRONT HOOK  
REAR HOOK

SCALE.. 1/8" = 1" UNLESS OTHERWISE NOTED.

FULL SIZE. 047 WIRE BOTH FITTINGS

NOTE.. FITTINGS BENT TO HOOK SHAPE AFTER INSERTED ON STABILIZER.

LEADING EDGE 1/2 BY 3/4 BALS.

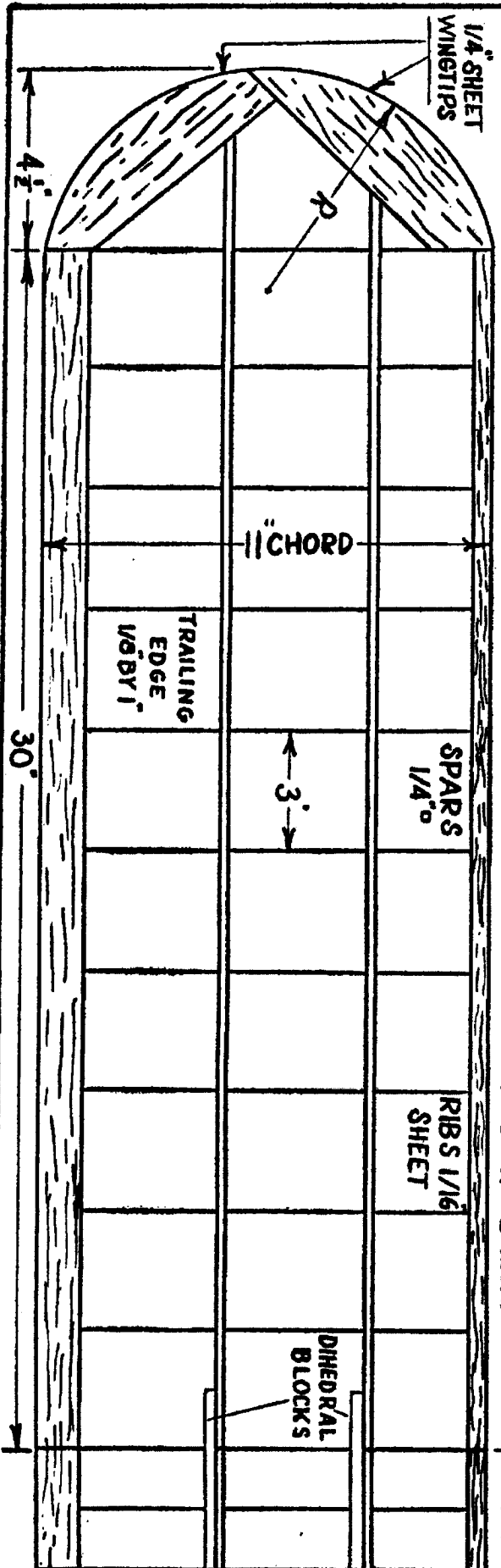

3" CENTER SECTION

SPARS 1/4"

RIBS 1/16 SHEET

3"

DIHEDRAL BLOCKS

11" CHORD

TRAILING EDGE 1/8 BY 1"

30"

4 1/2"

1/4" SHEET WINGTIPS

ALL HOLES 1/16 DIA.

ALUM. PLATES PROTECT STABILIZER

BOTH PLATES 1/32 THICK

STABILIZER TIPS 1/4" SHEET

NOTE..

FITTINGS BENT TO HOOK SHAPE AFTER INSERTED ON STABILIZER.

